

*If you have questions or comments, contact us.
Pour toute question ou tout commentaire, nous contacter.
Si tiene dudas o comentarios, contáctenos.*

1-800-4-DEWALT • www.dewalt.com

**INSTRUCTION MANUAL
GUIDE D'UTILISATION
MANUAL DE INSTRUCCIONES**

INSTRUCTIVO DE OPERACIÓN, CENTROS DE SERVICIO Y PÓLIZA DE GARANTÍA. **ADVERTENCIA:** LÉASE ESTE INSTRUCTIVO ANTES DE USAR EL PRODUCTO.

DEWALT®

**DCG412
20V Max* Cordless Grinder
Cordless Grinder sans fil 20 V max*
20 V Máx* Cordless Grinder**

Definitions: Safety Guidelines

The definitions below describe the level of severity for each signal word. Please read the manual and pay attention to these symbols.

▲ DANGER: Indicates an imminently hazardous situation which, if not avoided, **will** result in **death or serious injury**.

▲ WARNING: Indicates a potentially hazardous situation which, if not avoided, **could** result in **death or serious injury**.

▲ CAUTION: Indicates a potentially hazardous situation which, if not avoided, **may** result in **minor or moderate injury**.

NOTICE: Indicates a practice **not related to personal injury** which, if not avoided, **may** result in **property damage**.

IF YOU HAVE ANY QUESTIONS OR COMMENTS ABOUT THIS OR ANY DEWALT TOOL, CALL US TOLL FREE AT: **1-800-4-DeWALT (1-800-433-9258)**.



WARNING: To reduce the risk of injury, read the instruction manual.

General Power Tool Safety Warnings



WARNING! Read all safety warnings and all instructions. Failure to follow the warnings and instructions may result in electric shock, fire and/or serious injury.

SAVE ALL WARNINGS AND INSTRUCTIONS FOR FUTURE REFERENCE

The term "power tool" in the warnings refers to your mains-operated (corded) power tool or battery-operated (cordless) power tool.

1) WORK AREA SAFETY

- a) **Keep work area clean and well lit.** Cluttered or dark areas invite accidents.
- b) **Do not operate power tools in explosive atmospheres, such as in the presence of flammable liquids, gases or dust.** Power tools create sparks which may ignite the dust or fumes.
- c) **Keep children and bystanders away while operating a power tool.** Distractions can cause you to lose control.

2) ELECTRICAL SAFETY

- a) **Power tool plugs must match the outlet. Never modify the plug in any way. Do not use any adapter plugs with earthed (grounded) power tools.** Unmodified plugs and matching outlets will reduce risk of electric shock.
- b) **Avoid body contact with earthed or grounded surfaces such as pipes, radiators, ranges and refrigerators.** There is an increased risk of electric shock if your body is earthed or grounded.
- c) **Do not expose power tools to rain or wet conditions.** Water entering a power tool will increase the risk of electric shock.
- d) **Do not abuse the cord. Never use the cord for carrying, pulling or unplugging the power tool. Keep cord away from heat, oil, sharp edges or moving parts.** Damaged or entangled cords increase the risk of electric shock.
- e) **When operating a power tool outdoors, use an extension cord suitable for outdoor use.** Use of a cord suitable for outdoor use reduces the risk of electric shock.
- f) **If operating a power tool in a damp location is unavoidable, use a ground fault circuit interrupter (GFCI) protected supply.** Use of a GFCI reduces the risk of electric shock.

3) PERSONAL SAFETY

- a) **Stay alert, watch what you are doing and use common sense when operating a power tool. Do not use a power tool while you are tired or under the influence of drugs, alcohol or medication.** A moment of inattention while operating power tools may result in serious personal injury.
- b) **Use personal protective equipment. Always wear eye protection.** Protective equipment such as dust mask, non-skid safety shoes, hard hat, or hearing protection used for appropriate conditions will reduce personal injuries.
- c) **Prevent unintentional starting. Ensure the switch is in the off position before connecting to power source and/or battery pack, picking up or carrying the tool.** Carrying power tools with your finger on the switch or energizing power tools that have the switch on invites accidents.
- d) **Remove any adjusting key or wrench before turning the power tool on.** A wrench or a key left attached to a rotating part of the power tool may result in personal injury.
- e) **Do not overreach. Keep proper footing and balance at all times.** This enables better control of the power tool in unexpected situations.
- f) **Dress properly. Do not wear loose clothing or jewelry. Keep your hair, clothing and gloves away from moving parts.** Loose clothes, jewelry or long hair can be caught in moving parts.
- g) **If devices are provided for the connection of dust extraction and collection facilities, ensure these are connected and properly used.** Use of dust collection can reduce dust-related hazards.

4) POWER TOOL USE AND CARE

- a) **Do not force the power tool. Use the correct power tool for your application.** The correct power tool will do the job better and safer at the rate for which it was designed.

- b) **Do not use the power tool if the switch does not turn it on and off.** Any power tool that cannot be controlled with the switch is dangerous and must be repaired.
 - c) **Disconnect the plug from the power source and/or the battery pack from the power tool before making any adjustments, changing accessories, or storing power tools.** Such preventive safety measures reduce the risk of starting the power tool accidentally.
 - d) **Store idle power tools out of the reach of children and do not allow persons unfamiliar with the power tool or these instructions to operate the power tool.** Power tools are dangerous in the hands of untrained users.
 - e) **Maintain power tools. Check for misalignment or binding of moving parts, breakage of parts and any other condition that may affect the power tool's operation. If damaged, have the power tool repaired before use.** Many accidents are caused by poorly maintained power tools.
 - f) **Keep cutting tools sharp and clean.** Properly maintained cutting tools with sharp cutting edges are less likely to bind and are easier to control.
 - g) **Use the power tool, accessories and tool bits etc., in accordance with these instructions taking into account the working conditions and the work to be performed.** Use of the power tool for operations different from those intended could result in a hazardous situation.
- ### 5) BATTERY TOOL USE AND CARE
- a) **Recharge only with the charger specified by the manufacturer.** A charger that is suitable for one type of battery pack may create a risk of fire when used with another battery pack.
 - b) **Use power tools only with specifically designated battery packs.** Use of any other battery packs may create a risk of injury and fire.

- c) **When battery pack is not in use, keep it away from other metal objects like paper clips, coins, keys, nails, screws, or other small metal objects that can make a connection from one terminal to another.** Shorting the battery terminals together may cause burns or a fire.
 - d) **Under abusive conditions, liquid may be ejected from the battery; avoid contact. If contact accidentally occurs, flush with water. If liquid contacts eyes, additionally seek medical help.** Liquid ejected from the battery may cause irritation or burns.
- 6) SERVICE**
- a) **Have your power tool serviced by a qualified repair person using only identical replacement parts.** This will ensure that the safety of the power tool is maintained.

SAFETY INSTRUCTIONS FOR ALL OPERATIONS

Safety Warnings Common for Grinding, Sanding, Wire Brushing, Polishing or Abrasive, Cutting-Off Operations

- a) **This power tool is intended to function as a grinder, sander, wire brush, polisher or cut-off tool. Read all safety warnings, instructions, illustrations and specifications provided with this power tool.** Failure to follow all instructions listed below may result in electric shock, fire and/or serious injury.
- b) **Do not use accessories which are not specifically designed and recommended by the tool manufacturer.** Just because the accessory can be attached to your power tool, it does not assure safe operation.

- c) **The rated speed of the accessory must be at least equal to the maximum speed marked on the power tool.** Accessories running faster than their rated speed can break and fly apart.
- d) **The outside diameter and the thickness of your accessory must be within the capacity rating of your power tool.** Incorrectly sized accessories cannot be adequately guarded or controlled.
- e) **Threaded mounting of accessories must match the grinder spindle thread.** For accessories mounted by flanges, the arbor hole of the accessory must fit the locating diameter of the flange. Accessories that do not match the mounting hardware of the power tool will run out of balance, vibrate excessively and may cause loss of control.
- f) **Do not use a damaged accessory. Before each use inspect the accessory such as abrasive wheels for chips and cracks, backing pad for cracks, tear or excess wear, wire brush for loose or cracked wires. If power tool or accessory is dropped, inspect for damage or install an undamaged accessory. After inspecting and installing an accessory, position yourself and bystanders away from the plane of the rotating accessory and run the power tool at maximum no-load speed for one minute.** Damaged accessories will normally break apart during this test time.
- g) **Wear personal protective equipment. Depending on application, use face shield, safety goggles or safety glasses. As appropriate, wear dust mask, hearing protectors, gloves and workshop apron capable of stopping small abrasive or workpiece fragments.** The eye protection must be capable of stopping flying debris generated by various operations. The dust mask or respirator must be capable of filtrating particles generated by your operation.

Prolonged exposure to high intensity noise may cause hearing loss.

- h) **Keep bystanders a safe distance away from work area. Anyone entering the work area must wear personal protective equipment.** Fragments of workpiece or of a broken accessory may fly away and cause injury beyond immediate area of operation.
- i) **Hold the power tool by insulated gripping surfaces only, when performing an operation where the cutting accessory may contact hidden wiring.** Cutting accessory contacting a "live" wire may make exposed metal parts of the power tool "live" and shock the operator.
- j) **Position the cord clear of the spinning accessory.** If you lose control, the cord may be cut or snagged and your hand or arm may be pulled into the spinning accessory.
- k) **Never lay the power tool down until the accessory has come to a complete stop.** The spinning accessory may grab the surface and pull the power tool out of your control.
- l) **Do not run the power tool while carrying it at your side.** Accidental contact with the spinning accessory could snag your clothing, pulling the accessory into your body.
- m) **Regularly clean the power tool's air vents.** The motor's fan will draw the dust inside the housing and excessive accumulation of powdered metal may cause electrical hazards.
- n) **Do not operate the power tool near flammable materials.** Sparks could ignite these materials.
- o) **Do not use accessories that require liquid coolants.** Using water or other liquid coolants may result in electrocution or shock.
- p) **Do not use Type 11 (flaring cup) wheels on this tool.** Using inappropriate accessories can result in injury.

- q) **Always use side handle. Tighten the handle securely.** The side handle should always be used to maintain control of the tool at all times.
- r) **When starting the tool with a new or replacement wheel, or a new or replacement wire brush installed, hold the tool in a well protected area and let it run for one minute.** If the wheel has an undetected crack or flaw, it should burst in less than one minute. If the wire brush has loose wires, they will be detected. Never start the tool with a person in line with the wheel. This includes the operator.

Causes and Operator Prevention of Kickback

Kickback is a sudden reaction to a pinched or snagged rotating wheel, backing pad, brush or any other accessory. Pinching or snagging causes rapid stalling of the rotating accessory which in turn causes the uncontrolled power tool to be forced in the direction opposite of the accessory's rotation at the point of the binding.

For example, if an abrasive wheel is snagged or pinched by the workpiece, the edge of the wheel that is entering into the pinch point can dig into the surface of the material causing the wheel to climb out or kick out. The wheel may either jump toward or away from the operator, depending on direction of the wheel's movement at the point of pinching. Abrasive wheels may also break under these conditions.

Kickback is the result of tool misuse and/or incorrect operating procedures or conditions and can be avoided by taking proper precautions as given below:

- a) **Maintain a firm grip on the power tool and position your body and arm to allow you to resist kickback forces. Always use auxiliary handle, if provided, for maximum control over kickback or torque reaction during start up.**

The operator can control torque reaction or kickback forces, if proper precautions are taken.

- b) **Never place your hand near the rotating accessory.** Accessory may kickback over your hand.
- c) **Do not position your body in the area where power tool will move if kickback occurs.** Kickback will propel the tool in direction opposite to the wheel's movement at the point of snagging.
- d) **Use special care when working corners, sharp edges etc. Avoid bouncing and snagging the accessory.** Corners, sharp edges or bouncing have a tendency to snag the rotating accessory and cause loss of control or kickback.
- e) **Do not attach a saw chain woodcarving blade or toothed saw blade.** Such blades create frequent kickback and loss of control.

Safety Warnings Specific for Grinding and Abrasive Cutting-Off Operations

- a) **Use only wheel types that are recommended for your power tool and the specific guard designed for the selected wheel.** Wheels for which the power tool was not designed cannot be adequately guarded and are unsafe.
- b) **The grinding surface of center depressed wheels must be mounted below the plane of the guard lip.** An improperly mounted wheel that projects through the plane of the guard lip cannot be adequately protected.
- c) **The guard must be securely attached to the power tool and positioned for maximum safety, so the least amount of wheel is exposed towards the operator.** The guard helps to protect operator from broken wheel fragments and accidental contact with wheel.

- d) **Wheels must be used only for recommended applications. For example: do not grind with the side of cut-off wheel.** Abrasive cut-off wheels are intended for peripheral grinding, side forces applied to these wheels may cause them to shatter.
- e) **Always use undamaged wheel flanges that are of correct size and shape for your selected wheel.** Proper wheel flanges support the wheel thus reducing the possibility of wheel breakage. Flanges for cut-off wheels may be different from grinding wheel flanges.
- f) **Do not use worn down wheels from larger power tools.** Wheel intended for larger power tool is not suitable for the higher speed of a smaller tool and may burst.

Additional Safety Warnings Specific for Abrasive Cutting-Off Operations

- a) **Do not "jam" the cut-off wheel or apply excessive pressure. Do not attempt to make an excessive depth of cut.** Overstressing the wheel increases the loading and susceptibility to twisting or binding of the wheel in the cut and the possibility of kickback or wheel breakage.
- b) **Do not position your body in line with and behind the rotating wheel.** When the wheel, at the point of operation, is moving away from your body, the possible kickback may propel the spinning wheel and the power tool directly at you.
- c) **When wheel is binding or when interrupting a cut for any reason, switch off the power tool and hold the power tool motionless until the wheel comes to a complete stop. Never attempt to remove the cut-off wheel from the cut while the wheel is in motion otherwise kickback may occur.** Investigate and take corrective action to eliminate the cause of wheel binding.

- d) **Do not restart the cutting operation in the workpiece. Let the wheel reach full speed and carefully reenter the cut.** The wheel may bind, walk up or kickback if the power tool is restarted in the workpiece.
- e) **Support panels or any oversized workpiece to minimize the risk of wheel pinching and kickback.** Large workpieces tend to sag under their own weight. Supports must be placed under the workpiece near the line of cut and near the edge of the workpiece on both sides of the wheel.
- f) **Use extra caution when making a “pocket cut” into existing walls or other blind areas.** The protruding wheel may cut gas or water pipes, electrical wiring or objects that can cause kickback.

Safety Warnings Specific for Sanding Operations

- a) **Do not use excessively oversized sanding disc paper. Follow manufacturers recommendations, when selecting sanding paper.** Larger sanding paper extending beyond the sanding pad presents a laceration hazard and may cause snagging, tearing of the disc or kickback.

Safety Warnings Specific for Polishing Operations

- a) **Do not allow any loose portion of the polishing bonnet or its attachment strings to spin freely. Tuck away or trim any loose attachment strings.** Loose and spinning attachment strings can entangle your fingers or snag on the workpiece.

Safety Warnings Specific for Wire Brushing Operations

- a) **Be aware that wire bristles are thrown by the brush even during ordinary operation. Do not overstress the wires by applying excessive load to the brush.** The wire bristles can easily penetrate light clothing and/or skin.
- b) **If the use of a guard is recommended for wire brushing, do not allow any interference of the wire wheel or brush with the guard.** Wire wheel or brush may expand in diameter due to work and centrifugal forces.
- c) **Safety goggles or safety glasses with side shields and a full face shield compliant with ANSI Z87.1 MUST be worn by the operator and others that are within 50' (15.2 m) of the use of this product.**

Additional Safety Information

⚠ WARNING: ALWAYS use safety glasses. Everyday eyeglasses are NOT safety glasses. Also use face or dust mask if cutting operation is dusty. ALWAYS WEAR CERTIFIED SAFETY EQUIPMENT:

- ANSI Z87.1 eye protection (CAN/CSA Z94.3),
- ANSI S12.6 (S3.19) hearing protection,
- NIOSH/OSHA/MSHA respiratory protection.

⚠ WARNING: Some dust created by power sanding, sawing, grinding, drilling, and other construction activities contains chemicals known to the State of California to cause cancer, birth defects or other reproductive harm. Some examples of these chemicals are:

- lead from lead-based paints,
- crystalline silica from bricks and cement and other masonry products, and
- arsenic and chromium from chemically-treated lumber.

Your risk from these exposures varies, depending on how often you do this type of work. To reduce your exposure to these chemicals: work in a well ventilated area, and work with approved safety equipment, such as those dust masks that are specially designed to filter out microscopic particles.

- **Avoid prolonged contact with dust from power sanding, sawing, grinding, drilling, and other construction activities. Wear protective clothing and wash exposed areas with soap and water.** Allowing dust to get into your mouth, eyes, or lay on the skin may promote absorption of harmful chemicals.

⚠WARNING: Use of this tool can generate and/or disperse dust, which may cause serious and permanent respiratory or other injury. Always use NIOSH/OSHA approved respiratory protection appropriate for the dust exposure. Direct particles away from face and body.

⚠WARNING: Always wear proper personal hearing protection that conforms to ANSI S12.6 (S3.19) during use. Under some conditions and duration of use, noise from this product may contribute to hearing loss.

⚠WARNING: Always use eye protection. All users and bystanders must wear eye protection that conforms to ANSI Z87.1.

⚠WARNING: When not in use, place grinder on a stable surface where it will not move inadvertently, roll or cause a tripping or falling hazard. The grinder may stand upright on the battery pack but may be easily knocked over. Serious personal injury may result.

⚠CAUTION: To reduce the risk of personal injury, use extra care when working into a corner or edge because a sudden, sharp movement of the tool may be experienced when the wheel or other accessory contacts a secondary surface or a surface edge.

- The label on your tool may include the following symbols. The symbols and their definitions are as follows:

V..... volts	A..... amperes
Hz..... hertz	W..... watts
min minutes	~ or AC..... alternating current
== or DC... direct current	⎓ or AC/DC... alternating or direct current
Ⓛ..... Class I Construction (grounded)	no no load speed
Ⓜ..... Class II Construction (double insulated)	n rated speed
.../min per minute	IPM..... impacts per minute
BPM beats per minute	RPM revolutions per minute
IPM..... impacts per minute	⊕..... earthing terminal
RPM revolutions per minute	⚠..... safety alert symbol
sfpm surface feet per minute	
SPM strokes per minute	

Important Safety Instructions for All Battery Packs

When ordering replacement battery packs, be sure to include the catalog number and voltage. Consult the chart at the end of this manual for compatibility of chargers and battery packs.

The battery pack is not fully charged out of the carton. Before using the battery pack and charger, read the safety instructions below and then follow charging procedures outlined.

READ ALL INSTRUCTIONS

- **Do not charge or use the battery pack in explosive atmospheres, such as in the presence of flammable liquids,**

gases or dust. Inserting or removing the battery pack from the charger may ignite the dust or fumes.

- **NEVER force the battery pack into the charger. DO NOT modify the battery pack in any way to fit into a non-compatible charger as battery pack may rupture causing serious personal injury.** Consult the chart at the end of this manual for compatibility of batteries and chargers.
- Charge the battery packs only in designated DEWALT chargers.
- **DO NOT** splash or immerse in water or other liquids.
- **Do not store or use the tool and battery pack in locations where the temperature may reach or exceed 105 °F (40 °C) (such as outside sheds or metal buildings in summer).** For best life store battery packs in a cool, dry location.

NOTE: Do not store the battery packs in a tool with the trigger switch locked on. Never tape the trigger switch in the ON position.

⚠WARNING: Fire hazard. Never attempt to open the battery pack for any reason. If the battery pack case is cracked or damaged, do not insert into the charger. Do not crush, drop or damage the battery pack. Do not use a battery pack or charger that has received a sharp blow, been dropped, run over or damaged in any way (e.g., pierced with a nail, hit with a hammer, stepped on). Damaged battery packs should be returned to the service center for recycling.

⚠WARNING: Fire hazard. Do not store or carry the battery pack so that metal objects can contact exposed battery terminals. For example, do not place the battery pack in aprons, pockets, tool boxes, product kit boxes, drawers, etc., with loose nails, screws, keys, etc. **Transporting batteries can possibly cause fires if the battery terminals inadvertently come in contact with conductive materials such as keys, coins, hand tools and the like.** The US Department of Transportation Hazardous Material Regulations (HMR) actually prohibit transporting batteries in

commerce or on airplanes (e.g., packed in suitcases and carry-on luggage) **UNLESS** they are properly protected from short circuits. So when transporting individual battery packs, make sure that the battery terminals are protected and well insulated from materials that could contact them and cause a short circuit.

SPECIFIC SAFETY INSTRUCTIONS FOR LITHIUM ION (Li-Ion)

- **Do not incinerate the battery pack even if it is severely damaged or is completely worn out.** The battery pack can explode in a fire. Toxic fumes and materials are created when lithium ion battery packs are burned.
- **If battery contents come into contact with the skin, immediately wash area with mild soap and water.** If battery liquid gets into the eye, rinse water over the open eye for 15 minutes or until irritation ceases. If medical attention is needed, the battery electrolyte is composed of a mixture of liquid organic carbonates and lithium salts.
- **Contents of opened battery cells may cause respiratory irritation.** Provide fresh air. If symptoms persist, seek medical attention.

⚠WARNING: Burn hazard. Battery liquid may be flammable if exposed to spark or flame.

The RBRC™ Seal

The RBRC™ (Rechargeable Battery Recycling Corporation) Seal on the nickel cadmium, nickel metal hydride or lithium ion batteries (or battery packs) indicate that the costs to recycle these batteries (or battery packs) at the end of their useful life have already been paid by DEWALT. In some areas, it is illegal to place spent nickel cadmium, nickel metal hydride or lithium ion batteries in the trash or municipal solid waste stream and the RBRC program provides an environmentally conscious alternative.



RBRC™, in cooperation with DEWALT and other battery users, has established programs in the United States and Canada to facilitate the collection of spent nickel cadmium, nickel metal hydride or lithium ion batteries. Help protect our environment and conserve natural resources by returning the spent nickel cadmium, nickel metal hydride or lithium ion batteries to an authorized DEWALT service center or to your local retailer for recycling. You may also contact your local recycling center for information on where to drop off the spent battery.

RBRC™ is a registered trademark of the Rechargeable Battery Recycling Corporation.

Important Safety Instructions for All Battery Chargers

SAVE THESE INSTRUCTIONS: This manual contains important safety and operating instructions for battery chargers.

- Before using the charger, read all instructions and cautionary markings on the charger, battery pack and product using the battery pack.

⚠ WARNING: Shock hazard. Do not allow any liquid to get inside the charger. Electric shock may result.

⚠ CAUTION: Burn hazard. To reduce the risk of injury, charge only DEWALT rechargeable battery packs. Other types of batteries may overheat and burst resulting in personal injury and property damage.

NOTICE: Under certain conditions, with the charger plugged into the power supply, the charger can be shorted by foreign material. Foreign materials of a conductive nature, such as, but not limited to, grinding dust, metal chips, steel wool, aluminum foil or any buildup of metallic particles should be kept away from the charger cavities. Always unplug the charger from the power supply when there is no battery pack in the cavity. Unplug the charger before attempting to clean.

- **DO NOT attempt to charge the battery pack with any chargers other than the ones in this manual.** The charger and battery pack are specifically designed to work together.
- **These chargers are not intended for any uses other than charging DEWALT rechargeable batteries.** Any other uses may result in risk of fire, electric shock or electrocution.
- **Do not expose the charger to rain or snow.**
- **Pull by the plug rather than the cord when disconnecting the charger.** This will reduce the risk of damage to the electric plug and cord.
- **Make sure that the cord is located so that it will not be stepped on, tripped over or otherwise subjected to damage or stress.**
- **Do not use an extension cord unless it is absolutely necessary.** Use of improper extension cord could result in risk of fire, electric shock or electrocution.
- **When operating a charger outdoors, always provide a dry location and use an extension cord suitable for outdoor use.** Use of a cord suitable for outdoor use reduces the risk of electric shock.
- **An extension cord must have adequate wire size (AWG or American Wire Gauge) for safety.** The smaller the gauge number of the wire, the greater the capacity of the cable, that is, 16 gauge has more capacity than 18 gauge. An undersized cord will cause a drop in line voltage resulting in loss of power and overheating. When using more than one extension to make up the total length, be sure each individual extension contains at least the minimum wire size. The following table shows the correct size to use depending on cord length and nameplate ampere rating. If in doubt, use the next heavier gauge. The lower the gauge number, the heavier the cord.

Minimum Gauge for Cord Sets						
Ampere Rating		Volts	Total Length of Cord in Feet (meters)			
		120V	25 (7.6)	50 (15.2)	100 (30.5)	150 (45.7)
		240V	50 (15.2)	100 (30.5)	200 (61.0)	300 (91.4)
More Than	Not More Than	AWG				
0	6		18	16	16	14
6	10		18	16	14	12
10	12		16	16	14	12
12	16		14	12	Not Recommended	

- **Do not place any object on top of the charger or place the charger on a soft surface that might block the ventilation slots and result in excessive internal heat.** Place the charger in a position away from any heat source. The charger is ventilated through slots in the top and the bottom of the housing.
- **Do not operate the charger with a damaged cord or plug.**
- **Do not operate the charger if it has received a sharp blow, been dropped or otherwise damaged in any way.** Take it to an authorized service center.
- **Do not disassemble the charger; take it to an authorized service center when service or repair is required.** Incorrect reassembly may result in a risk of electric shock, electrocution or fire.
- **Disconnect the charger from the outlet before attempting any cleaning. This will reduce the risk of electric shock.** Removing the battery pack will not reduce this risk.
- **NEVER attempt to connect 2 chargers together.**
- **The charger is designed to operate on standard 120V household electrical power. Do not attempt to use it on any other voltage.** This does not apply to the vehicular charger.

Chargers

Your tool uses a DEWALT charger. Be sure to read all safety instructions before using your charger. Consult the chart at the end of this manual for compatibility of chargers and battery packs.

Charging Procedure

1. Plug the charger into an appropriate outlet before inserting the battery pack.
2. Insert the battery pack (J) into the charger, as shown in Figure 1, making sure the pack is fully seated in charger. The red (charging) light will blink continuously, indicating that the charging process has started.
3. The completion of charge will be indicated by the red light remaining ON continuously. The pack is fully charged and may be used at this time or left in the charger.

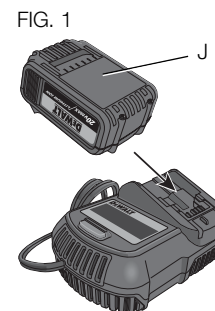

Indicator Light Operation

	PACK CHARGING	— — — — —
	PACK CHARGED	—————
	HOT/COLD DELAY	—• —• —• —• —•
	PROBLEM PACK OR CHARGER	••••••••
	PROBLEM POWERLINE	•• •• •• •• ••

Charge Indicators

This charger is designed to detect certain problems that can arise. Problems are indicated by the red light flashing at a fast rate. If this occurs, re-insert the battery pack into the charger. If the problem persists, try a different battery pack to determine if the charger is working properly. If the new pack charges correctly, then the original pack is defective and should be returned to a service center or other collection site for recycling. If the new battery pack elicits the same trouble indication as the original, have the charger and the battery pack tested at an authorized service center.

HOT/COLD DELAY

This charger has a hot/cold delay feature: when the charger detects a battery that is hot, it automatically starts a delay, suspending charging until the battery has cooled. After the battery has cooled, the charger automatically switches to the pack charging mode. This feature ensures maximum battery life. The red light flashes long, then short while in the hot/cold delay mode.

LEAVING THE BATTERY PACK IN THE CHARGER

The charger and battery pack can be left connected with the charge indicator showing Pack Charged.

WEAK BATTERY PACKS: Weak batteries will continue to function but should not be expected to perform as much work.

FAULTY BATTERY PACKS: This charger will not charge a faulty battery pack. The charger will indicate faulty battery pack by refusing to light or by displaying problem pack or charger.

NOTE: This could also mean a problem with a charger.

PROBLEM POWER LINE

Some chargers have a Problem Powerline indicator. When the charger is used with some portable power sources such as generators or sources that convert DC to AC, the charger may temporarily suspend

operation, flashing the red light with two fast blinks followed by a pause. This indicates the power source is out of limits.

Important Charging Notes

1. Longest life and best performance can be obtained if the battery pack is charged when the air temperature is between 65 °F and 75 °F (18 °–24 °C). DO NOT charge the battery pack in an air temperature below +40 °F (+4.5 °C), or above +105 °F (+40.5 °C). This is important and will prevent serious damage to the battery pack.
2. The charger and battery pack may become warm to the touch while charging. This is a normal condition, and does not indicate a problem. To facilitate the cooling of the battery pack after use, avoid placing the charger or battery pack in a warm environment such as in a metal shed or an uninsulated trailer.
3. A cold battery pack will charge at about half the rate of a warm battery pack. The battery pack will charge at that slower rate throughout the entire charging cycle and will not return to maximum charge rate even if the battery pack warms.
4. If the battery pack does not charge properly:
 - a. Check operation of receptacle by plugging in a lamp or other appliance;
 - b. Check to see if receptacle is connected to a light switch which turns power off when you turn out the lights;
 - c. Move the charger and battery pack to a location where the surrounding air temperature is approximately 65 °F–75 °F (18 °–24 °C);
 - d. If charging problems persist, take the tool, battery pack and charger to your local service center.
5. The battery pack should be recharged when it fails to produce sufficient power on jobs which were easily done previously. DO NOT CONTINUE to use under these conditions. Follow the

charging procedure. You may also charge a partially used pack whenever you desire with no adverse effect on the battery pack.

6. Foreign materials of a conductive nature such as, but not limited to, grinding dust, metal chips, steel wool, aluminum foil, or any buildup of metallic particles should be kept away from charger cavities. Always unplug the charger from the power supply when there is no battery pack in the cavity. Unplug the charger before attempting to clean.

7. Do not freeze or immerse the charger in water or any other liquid.

⚠ WARNING: Shock hazard. Don't allow any liquid to get inside the charger. Electric shock may result.

⚠ WARNING: Burn hazard. Do not submerge the battery pack in any liquid or allow any liquid to enter the battery pack. Never attempt to open the battery pack for any reason. If the plastic housing of the battery pack breaks or cracks, return to a service center for recycling.

Storage Recommendations

1. The best storage place is one that is cool and dry, away from direct sunlight and excess heat or cold.
2. For long storage, it is recommended to store a fully charged battery pack in a cool dry place out of the charger for optimal results.

NOTE: Battery packs should not be stored completely depleted of charge. The battery pack will need to be recharged before use.

**SAVE THESE INSTRUCTIONS
FOR FUTURE USE**

FIG. 2

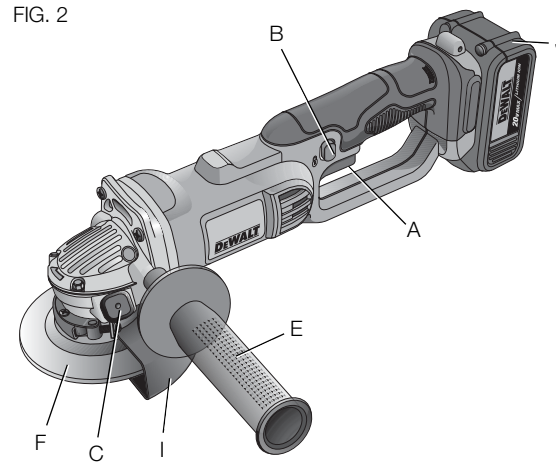

Components (Fig. 2, 9)

- | | |
|-------------------------------|---------------------------------------|
| A. Trigger switch | G. Unthreaded backing flange (Fig. 9) |
| B. Lock-off button | H. Threaded locking flange (Fig. 9) |
| C. Spindle lock button | I. Type 27 Guard (5"/125 mm) |
| D. Spindle (Fig. 9) | J. Battery pack |
| E. Side handle | |
| F. Grinding wheel (5"/125 mm) | |

ASSEMBLY AND ADJUSTMENTS

Attaching Side Handle (Fig. 2)

The side handle (E) can be fitted to either side of the gear case in the threaded holes. Before using the tool, check that the handle is tightened securely.

To improve user comfort, the gear case will rotate 90° for cutting operations.

Rotating the Gear Case

⚠WARNING: To reduce the risk of serious personal injury, turn tool off and remove the battery pack before making any adjustments or removing/installing attachments or accessories. An accidental start-up can cause injury.

1. Remove the four corner screws attaching the gear case to motor housing.
2. Without separating the gear case from motor housing, rotate the gear case head to desired position.

NOTE: If the gear case and motor housing become separated by more than 1/8" (3.17 mm), the tool must be serviced and re-assembled by a DEWALT service center. Failure to have the tool serviced may cause brush, motor and bearing failure.

3. Reinstall screws to attach the gear case to the motor housing. Tighten screws to 20 in.-lbs. torque. Overtightening could cause screws to strip.

Accessories

The capacity of this tool is 5" (125 mm) diameter x 1/4" (6.35 mm) thick grinding or cutting wheels. It is important to choose the correct guards, backing pads and flanges to use with grinder accessories.

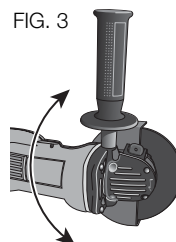

See pages 14 and 15 for information on choosing the correct accessories.

⚠WARNING: Accessories must be rated for at least the speed recommended on the tool warning label. Wheels and other accessories running over their rated accessory speed may fly apart and cause injury. Threaded accessories must have a 5/8"-11 hub. Every unthreaded accessory must have a 7/8" (22.2 mm) arbor hole. If it does not, it may have been designed for a circular saw. Use only the accessories shown on pages 14 and 15 of this manual. Accessory ratings must always be above tool speed as shown on tool nameplate.

⚠WARNING: Handle and store all abrasive wheels carefully to prevent damage from thermal shock, heat, mechanical damage, etc. Store in a dry protected area free from high humidity, freezing temperatures or extreme temperature changes.

Mounting Guard

MOUNTING AND REMOVING GUARD (FIG. 4, 5)

⚠WARNING: To reduce the risk of serious personal injury, turn tool off and remove the battery pack before making any adjustments or removing/installing attachments or accessories. An accidental start-up can cause injury.

⚠CAUTION: Guards must be used with all grinding wheels, cutting wheels, sanding flap discs, wire brushes, and wire wheels. The tool may be used without a guard only when sanding with conventional sanding discs. A Type 1 guard (intended for use with Type 1 cutting wheels and Type 27 wheels marked for cutting only) is available at extra cost from your local dealer or authorized service center. Grinding with wheels other than Type 27 and Type 29 require different accessory guards not included with the tool. A 1/4" (6.35 mm) thick, Type 27 guard is provided for use with the Type 27 wheel.

**4-1/2", 5" (115 mm, 125 mm)
Surface Grinding Wheels**

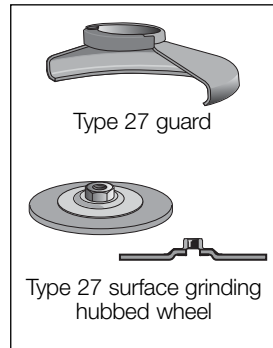
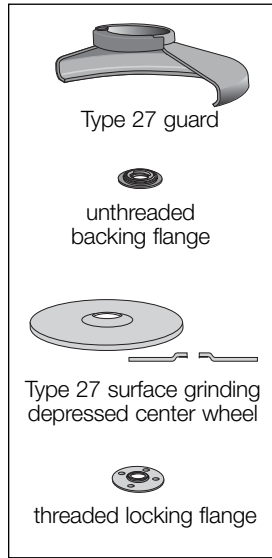

Wire Wheels

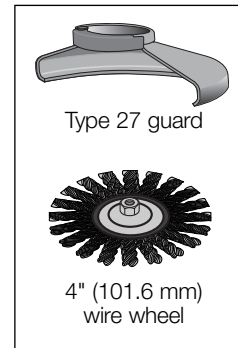
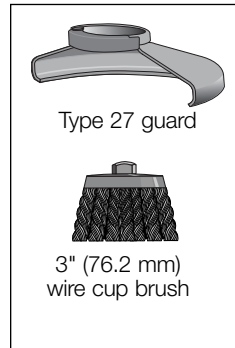

Sanding Discs

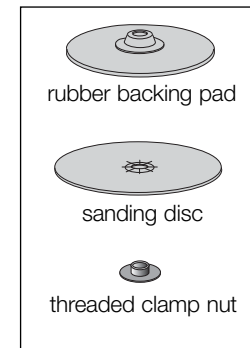

**4-1/2", 5" (115 mm, 125 mm)
Sanding Flap Discs**

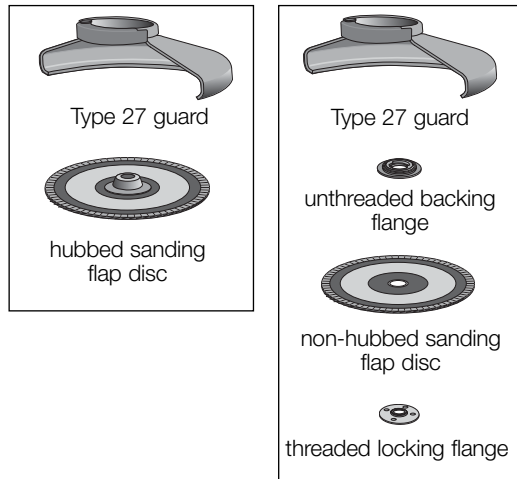

**4-1/2", 5" (115 mm, 125 mm)
Cutting Wheels**

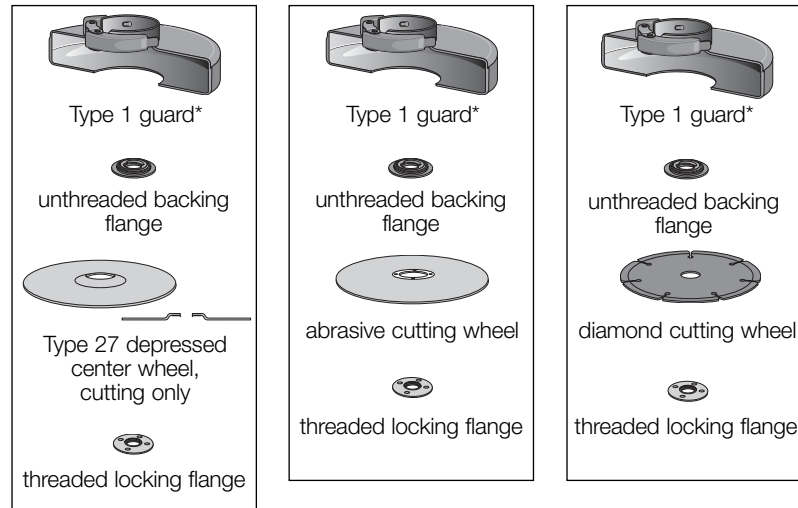

English

* **NOTE:** A Type 1 guard is available at extra cost from your local dealer or authorized service center.

1. Open the guard latch (K), and align the lugs (L) on the guard with the slots on the gear case (M). This will align the lugs on the guard with the slots on the gear case cover.
2. Push the guard down until the guard lugs engage and rotate freely in the groove on the gear case hub.
3. With the guard latch open, rotate the guard (I) into the desired working position. The guard body should be positioned between the spindle and the operator to provide maximum operator protection.
4. Close the guard latch to secure the guard on the gear case. You should not be able to rotate the guard by hand when the latch is closed. Do not operate the grinder with a loose guard or the clamp lever in open position.
5. To remove the guard, open the guard latch, rotate the guard so that the arrows are aligned and pull up on the guard.

FIG. 4

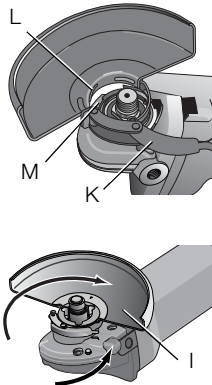
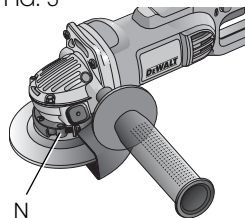

FIG. 5



NOTE: The guard is pre-adjusted to the diameter of the gear case hub at the factory. If, after a period of time, the guard becomes loose, tighten the adjusting screw (N) with clamp lever in the closed position with guard installed on the tool.

CAUTION: Do not tighten the adjusting screw with the clamp lever in the open position. Undetectable damage to the guard or the mounting hub may result.

CAUTION: If the guard cannot be tightened by the adjusting clamp, do not use the tool. To reduce the risk of personal injury, take the tool and guard to a service center to repair or replace the guard.

NOTE: Edge grinding and cutting can be performed with Type 27 wheels designed and specified for this purpose; 1/4" (6.35 mm) thick wheels are designed for surface grinding while thinner Type 27 wheels need to be examined for the manufacturer's label to see if they can be used for surface grinding or only edge grinding/cutting. A Type 1 guard must be used for any wheel where surface grinding is forbidden. Cutting can also be performed by using a Type 1 wheel and a Type 1 guard.

OPERATION

WARNING: To reduce the risk of serious personal injury, turn tool off and remove the battery pack before making any adjustments or removing/installing attachments or accessories. An accidental start-up can cause injury.

Installing and Removing the Battery Pack (Fig. 6)

NOTE: For best results, make sure your battery pack is fully charged.

FIG. 6

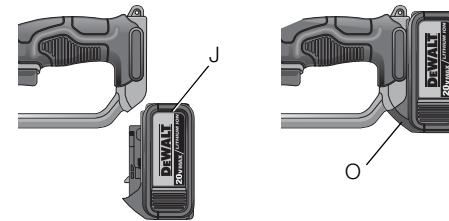

To install the battery pack (J) into the tool handle, align the battery pack with the rails inside the tool's handle and slide it into the handle.

until the battery pack is firmly seated in the tool and ensure that it does not disengage.

To remove the battery pack from the tool, press the release button (O) and firmly pull the battery pack out of the tool handle. Insert it into the charger as described in the charger section of this manual.

FUEL GAUGE BATTERY PACKS (FIG. 7)

Some DEWALT battery packs include a fuel gauge which consists of three green LED lights that indicate the level of charge remaining in the battery pack.

To actuate the fuel gauge, press and hold the fuel gauge button (P). A combination of the three green LED lights will illuminate designating the level of charge left. When the level of charge in the battery is below the usable limit, the fuel gauge will not illuminate and the battery will need to be recharged.

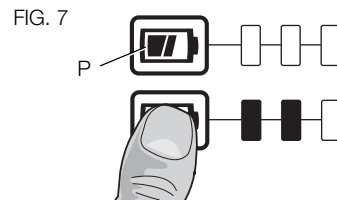

NOTE: The fuel gauge is only an indication of the charge left on the battery pack. It does not indicate tool functionality and is subject to variation based on product components, temperature and end-user application.

For more information regarding fuel gauge battery packs, please call 1-800-4-DEWALT (1-800-433-9258) or visit our website www.dewalt.com.

Switch

LOCK-OFF BUTTON AND TRIGGER SWITCH (FIG. 8)

Your grinder is equipped with a lock-off button (B).

To lock the trigger switch (A), press the lock-off button as shown in Figure 8. When the lock-off button is depressed to the lock icon, the unit is locked.

Always lock the trigger switch when carrying or storing the tool to eliminate unintentional starting.

FIG. 8

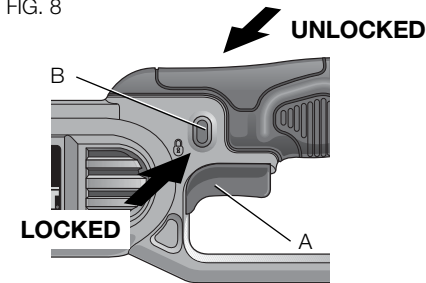

To unlock the trigger switch, press the lock-off button. When the lock-off button is depressed to the unlock icon, the unit is unlocked. The lock-off button is colored **red** to indicate when the switch is in its **unlocked** position.

Pull the trigger switch (A) to turn the motor ON. Releasing the trigger switch turns the motor OFF.

NOTE: This tool has no provision to lock the switch in the ON position, and should never be locked ON by any other means.

⚠ WARNING: Hold the side handle and body of the tool firmly to maintain control of the tool at start up and during use and until the wheel or accessory stops rotating. Make sure the wheel has come to a complete stop before laying the tool down.

⚠ WARNING: Allow the tool to reach full speed before touching tool to the work surface. Lift the tool from the work surface before turning the tool off.

SPINDLE LOCK BUTTON (FIG. 2)

The spindle lock button (C) is provided to prevent the spindle from rotating when installing or removing wheels. Operate the spindle lock button only when the tool is turned off, the battery is removed, and the wheel has come to a complete stop.

NOTICE: To reduce the risk of damage to the tool, do not engage the spindle lock button while the tool is operating. Damage to the tool will result and attached accessory may spin off possibly resulting in injury.

To engage the lock, depress the spindle lock button (C) and rotate the spindle until you are unable to rotate the spindle further.

Mounting and Using Depressed Center Grinding Wheels and Sanding Flap Discs

⚠ CAUTION: Always use the correct guard per the instructions in this manual.

MOUNTING AND REMOVING HUBBED WHEELS

⚠ WARNING: To reduce the risk of serious personal injury, turn tool off and remove the battery pack before making any adjustments or removing/installing attachments or accessories.

An accidental start-up can cause injury.

Hubbed wheels install directly on the 5/8"-11 threaded spindle.

1. Thread the wheel on the spindle by hand.
2. Depress the spindle lock button and use a wrench to tighten the hub of the wheel.
3. Reverse the above procedure to remove the wheel.

NOTICE: Failure to properly seat the wheel before turning the tool on may result in damage to the tool or the wheel.

MOUNTING NON-HUBBED WHEELS (FIG. 2, 9-10)

⚠ WARNING: To reduce the risk of serious personal injury, turn tool off and remove the battery pack before making any adjustments or removing/installing attachments or accessories. An accidental start-up can cause injury.

Depressed center Type 27 and Type 42 grinding wheels must be used with included flanges. See pages 14 and 15 of this manual for more information.

1. Install the unthreaded backing flange (G) on spindle (D) with the raised section (pilot) against the wheel.
2. Place wheel against the backing flange, centering the wheel on the raised section (pilot) of the backing flange.
3. While depressing the spindle lock button (C), thread the locking flange (H) on spindle. If the wheel you are installing is more than 1/8" (3.17 mm) thick, place the threaded locking flange on the spindle so that the raised section (pilot) fits into the center of the wheel. If the wheel you are installing is 1/8" (3.17 mm) thick or less, place the threaded locking flange on the spindle so that the raised section (pilot) is not against the wheel. Refer to Figure 10A and 10B.
4. While depressing the spindle lock button, tighten the threaded locking flange with a wrench.
5. To remove the wheel, depress the spindle lock button and loosen the threaded locking flange with a wrench.

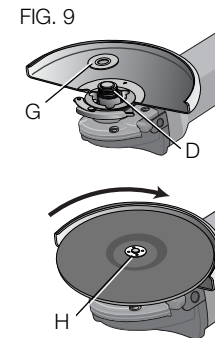

FIG. 10A

Wheels thicker than 1/8" (3.17 mm)

FIG. 10B

Wheels 1/8" (3.17 mm) and thinner

NOTE: If the wheel spins after the threaded locking flange is tightened, check the orientation of the threaded locking flange. If a thin wheel is installed with the pilot on the locking flange against the wheel, it will spin because the height of the pilot prevents the locking flange from holding the wheel.

SURFACE GRINDING WITH GRINDING WHEELS (FIG. 11)

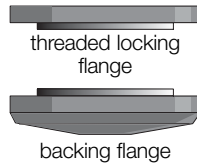
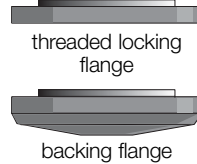
1. Allow the tool to reach full speed before touching the tool to the work surface.
2. Apply minimum pressure to the work surface, allowing the tool to operate at high speed. Grinding rate is greatest when the tool operates at high speed.
3. Maintain a 20° to 30° angle between the tool and work surface.
4. Continuously move the tool in a forward and back motion to avoid creating gouges in the work surface.
5. Remove the tool from work surface before turning tool off. Allow the tool to stop rotating before laying it down.

FIG. 11

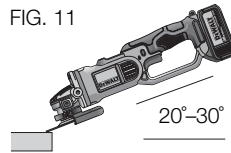
**EDGE GRINDING WITH GRINDING WHEELS (FIG. 12)**

CAUTION: Wheels used for edge grinding and cutting may break or kick back if they bend or twist while the tool is being used to do

cut-off work. In all edge grinding/cutting operations, the open side of the guard must be positioned away from the operator. Edge grinding/cutting with a Type 27 wheel must be limited to shallow cutting and notching—less than 1/2" (13 mm) in depth when the wheel is new. Reduce the depth of cutting/notching equal to the reduction of the wheel radius as it wears down. Refer to pages 14 and 15 for more information. Edge grinding/cutting with a Type 1 wheel requires usage of a Type 1 guard.

1. Allow the tool to reach full speed before touching the tool to the work surface.
2. Apply minimum pressure to the work surface, allowing the tool to operate at high speed. Grinding rate is greatest when the tool operates at high speed.
3. Position yourself so that the open-underside of the wheel is facing away from you.
4. Once a cut is begun and a notch is established in the workpiece, do not change the angle of the cut. Changing the angle will cause the wheel to bend and may cause wheel breakage. Edge grinding wheels are not designed to withstand side pressures caused by bending.
5. Remove the tool from the work surface before turning the tool off. Allow the tool to stop rotating before laying it down.

WARNING: Do not use edge grinding/cutting wheels for surface grinding applications if the wheel label has forbidden such use because these wheels are not designed for side pressures encountered with surface grinding. Wheel breakage and serious personal injury may result.

FIG. 12

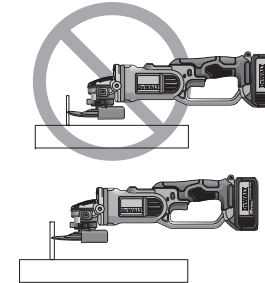

SURFACE FINISHING WITH SANDING FLAP DISCS (FIG. 13)

1. Allow the tool to reach full speed before touching the tool to the work surface.
2. Apply minimum pressure to work surface, allowing the tool to operate at high speed. Sanding rate is greatest when the tool operates at high speed.
3. Maintain a 5° to 10° angle between the tool and work surface.
4. Continuously move the tool in a forward and back motion to avoid creating gouges in the work surface.
5. Remove the tool from work surface before turning tool off. Allow the tool to stop rotating before laying it down.

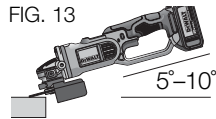
**MOUNTING SANDING BACKING PADS (FIG. 2, 14)**

⚠ WARNING: To reduce the risk of serious personal injury, turn tool off and remove the battery pack before making any adjustments or removing/installing attachments or accessories. An accidental start-up can cause injury.

NOTE: Guard may be removed when using sanding backing pads.

⚠ WARNING: Proper guard must be reinstalled for grinding wheel, cutting wheel, sanding flap disc, wire brush or wire wheel applications after sanding applications are complete.

1. Place or appropriately thread backing pad (Q) on the spindle.
2. Place the sanding disc (R) on the backing pad (Q).
3. While depressing the spindle lock button (C), thread the threaded clamp nut (S) on spindle, piloting the raised hub on the threaded clamp nut into the center of the sanding disc and backing pad.

4. Tighten the threaded clamp nut by hand. Then depress the spindle lock button while turning the sanding disc until the sanding disc and threaded locking flange are snug.
5. To remove the wheel, grasp and turn the backing pad and sanding disc while depressing the spindle lock button.

USING SANDING BACKING PADS (FIG. 15)

Choose the proper grit sanding discs for your application. Sanding discs are available in various grits. Coarse grits yield faster material removal rates and a rougher finish. Finer grits yield slower material removal and a smoother finish. Begin with coarse grit discs for fast, rough material removal. Move to a medium grit paper and finish with a fine grit disc for optimal finish.

Coarse	16–30 grit
Medium	36–80 grit
Fine Finishing	100–120 grit
Very Fine Finishing	150–180 grit

1. Allow the tool to reach full speed before touching tool to the work surface.
2. Apply minimum pressure to work surface, allowing the tool to operate at high speed. Sanding rate is greatest when the tool operates at high speed.
3. Maintain a 5° to 15° angle between the tool and work surface. The sanding disc should contact approximately 1" (25.4 mm) of work surface.

FIG. 14

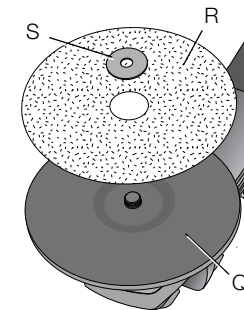
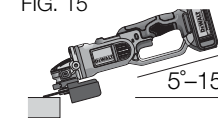

FIG. 15



4. Move the tool constantly in a straight line to prevent burning and swirling of work surface. Allowing the tool to rest on the work surface without moving, or moving the tool in a circular motion causes burning and swirling marks on the work surface.
5. Remove the tool from work surface before turning tool off. Allow the tool to stop rotating before laying it down.

Precautions To Take When Sanding Paint

1. Sanding of lead based paint is NOT RECOMMENDED due to the difficulty of controlling the contaminated dust. The greatest danger of lead poisoning is to children and pregnant women.
2. Since it is difficult to identify whether or not a paint contains lead without a chemical analysis, we recommend the following precautions when sanding any paint:

PERSONAL SAFETY

1. No children or pregnant women should enter the work area where the paint sanding is being done until all clean up is completed.
2. A dust mask or respirator should be worn by all persons entering the work area. The filter should be replaced daily or whenever the wearer has difficulty breathing.

NOTE: Only those dust masks suitable for working with lead paint dust and fumes should be used. Ordinary painting masks do not offer this protection. See your local hardware dealer for the proper N.I.O.S.H. approved mask.

3. NO EATING, DRINKING or SMOKING should be done in the work area to prevent ingesting contaminated paint particles. Workers should wash and clean up BEFORE eating, drinking or smoking. Articles of food, drink, or smoking should not be left in the work area where dust would settle on them.

ENVIRONMENTAL SAFETY

1. Paint should be removed in such a manner as to minimize the amount of dust generated.
2. Areas where paint removal is occurring should be sealed with plastic sheeting of 4 mils thickness.
3. Sanding should be done in a manner to reduce tracking of paint dust outside the work area.

CLEANING AND DISPOSAL

1. All surfaces in the work area should be vacuumed and thoroughly cleaned daily for the duration of the sanding project. Vacuum filter bags should be changed frequently.
2. Plastic drop cloths should be gathered up and disposed of along with any dust chips or other removal debris. They should be placed in sealed refuse receptacles and disposed of through regular trash pick-up procedures.
During clean up, children and pregnant women should be kept away from the immediate work area.
3. All toys, washable furniture and utensils used by children should be washed thoroughly before being used again.

Mounting and Using Wire Brushes and Wire Wheels

Wire cup brushes or wire wheels screw directly on the grinder spindle without the use of flanges. Use only wire brushes or wheels provided with a 5/8"-11 threaded hub. A Type 27 guard is required when using wire brushes and wheels.

⚠CAUTION: To reduce the risk of personal injury, wear work gloves when handling wire brushes and wheels. They can become sharp.

⚠CAUTION: To reduce the risk of damage to the tool, wheel or brush must not touch guard when mounted or while in use.

Undetectable damage could occur to the accessory, causing wires to fragment from accessory wheel or cup.

MOUNTING WIRE CUP BRUSHES AND WIRE WHEELS

⚠WARNING: To reduce the risk of serious personal injury, turn tool off and remove the battery pack before making any adjustments or removing/installing attachments or accessories.

An accidental start-up can cause injury.

1. Thread the wheel on the spindle by hand.
2. Depress spindle lock button and use a wrench on the hub of the wire wheel or brush to tighten the wheel.
3. To remove the wheel, reverse the above procedure.

NOTICE: To reduce the risk of damage to the tool, properly seat the wheel hub before turning the tool on.

USING WIRE CUP BRUSHES AND WIRE WHEELS (FIG. 16)

Wire wheels and brushes can be used for removing rust, scale and paint, and for smoothing irregular surfaces.

NOTE: The same precautions should be taken when wire brushing paint as when sanding paint (refer to **Precautions To Take When Sanding Paint**).

1. Allow the tool to reach full speed before touching the tool to the work surface.
2. Apply minimum pressure to work surface, allowing the tool to operate at high speed. Material removal rate is greatest when the tool operates at high speed.
3. Maintain a 5° to 10° angle between the tool and work surface for wire cup brushes.
4. Maintain contact between the edge of the wheel and the work surface with wire wheels.

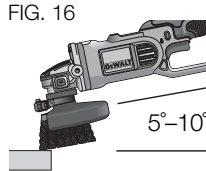

5. Continuously move the tool in a forward and back motion to avoid creating gouges in the work surface. Allowing the tool to rest on the work surface without moving, or moving the tool in a circular motion causes burning and swirling marks on the work surface.
6. Remove the tool from the work surface before turning the tool off. Allow the tool to stop rotating before setting it down.

⚠CAUTION: Use extra care when working over an edge, as a sudden sharp movement of grinder may be experienced.

Mounting and Using Type 1/Type 41 Cutting Wheels

NOTE: The Type 1 guard MUST be used and is available at extra cost from your local dealer or authorized service center.

Cutting wheels include diamond wheels and abrasive discs. Abrasive cutting wheels for metal and concrete use are available. Diamond blades for concrete cutting can also be used.

⚠WARNING: A closed, two-sided cutting wheel guard is required when using cutting wheels. Failure to use proper flange and guard can result in injury resulting from wheel breakage and wheel contact. See pages 14 and 15 for more information.

MOUNTING CLOSED (TYPE 1) GUARD (FIG. 17, 18)

⚠WARNING: To reduce the risk of serious personal injury, turn tool off and remove the battery pack before making any adjustments or removing/installing attachments or accessories.

An accidental start-up can cause injury.

1. Open the guard latch (V), and align the lugs (T) on the guard with the slots on the hub (U). This will align the lugs with slots on the gear case cover. Position the guard facing backward.
2. Push the guard down until the guard lug engages and rotates freely in the groove on the gear case hub.

3. Rotate guard (I) into desired working position. The guard body should be positioned between the spindle and the operator to provide maximum operator protection.
4. Close the guard latch to secure the guard on the gear case cover. You should be unable to rotate the guard by hand when the latch is in closed position. Do not operate grinder with a loose guard or clamp lever in open position.
5. To remove the guard, open the guard latch, rotate the guard so that the arrows are aligned and pull up on the guard.

NOTE: The guard is pre-adjusted to the diameter of the gear case hub at the factory. If, after a period of time, the guard becomes loose, tighten the adjusting screw (W) with the clamp lever in the closed position with guard installed on the tool.

NOTICE: To reduce the risk of damage to the tool, do not tighten adjusting screw with clamp lever in open position. Undetectable damage to guard or mounting hub may result.

MOUNTING TYPE 1 OR TYPE 41 CUTTING WHEELS

⚠WARNING: To reduce the risk of serious personal injury, turn tool off and remove the battery pack before making any adjustments or removing/installing attachments or accessories. An accidental start-up can cause injury.

FIG. 17

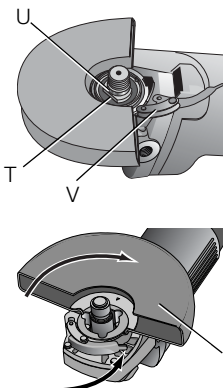
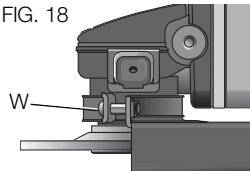

FIG. 18



⚠CAUTION: Matching diameter backing flange and threaded locking flange (included with tool) must be used for Type 1 and Type 41 cutting wheels.

1. Place the unthreaded backing flange on spindle with the raised section (pilot) facing up. The raised section (pilot) on the backing flange will be against the wheel when the wheel is installed.
2. Place the wheel on the backing flange, centering the wheel on the raised section (pilot).
3. Install the threaded locking flange with the raised section (pilot) facing away from the wheel.
4. Depress the spindle lock button and tighten threaded locking flange with a wrench.
5. To remove the wheel, depress the spindle lock button and loosen the threaded locking flange with a wrench.

USING TYPE 1 OR TYPE 41 CUTTING WHEELS

⚠WARNING: Do not use edge grinding/cutting wheels for surface grinding applications because these wheels are not designed for side pressures encountered with surface grinding. Wheel breakage and injury may result.

1. Allow tool to reach full speed before touching tool to work surface.
2. Apply minimum pressure to work surface, allowing tool to operate at high speed. Cutting rate is greatest when the tool operates at high speed.
3. Once a cut is begun and a notch is established in the workpiece, do not change the angle of the cut. Changing the angle will cause the wheel to bend and may cause wheel breakage.
4. Remove the tool from work surface before turning tool off. Allow the tool to stop rotating before setting it down.

MAINTENANCE

⚠ WARNING: *To reduce the risk of serious personal injury, turn tool off and remove the battery pack before making any adjustments or removing/installing attachments or accessories. An accidental start-up can cause injury.*

Cleaning

⚠ WARNING: *Blow dirt and dust out of all air vents with clean, dry air at least once a week. To minimize the risk of eye injury, always wear ANSI Z87.1 approved eye protection when performing this.*

⚠ WARNING: *Never use solvents or other harsh chemicals for cleaning the non-metallic parts of the tool. These chemicals may weaken the materials used in these parts. Use a cloth dampened only with water and mild soap. Never let any liquid get inside the tool; never immerse any part of the tool into a liquid.*

CHARGER CLEANING INSTRUCTIONS

⚠ WARNING: *Shock hazard. Disconnect the charger from the AC outlet before cleaning. Dirt and grease may be removed from the exterior of the charger using a cloth or soft non-metallic brush. Do not use water or any cleaning solutions.*

Lubrication

DEWALT tools are properly lubricated at the factory and are ready for use.

Repairs

The charger and battery pack are not serviceable. There are no serviceable parts inside the charger or battery pack.

To assure product SAFETY and RELIABILITY, repairs, maintenance and adjustments (including brush inspection and replacement) should be performed by a DEWALT factory service center, a DEWALT authorized service center or other qualified service personnel. Always use identical replacement parts.

Accessories

⚠ WARNING: *Since accessories, other than those offered by DEWALT, have not been tested with this product, use of such accessories with this tool could be hazardous. To reduce the risk of injury, only DEWALT recommended accessories should be used with this product.*

Recommended accessories for use with your tool are available at extra cost from your local dealer or authorized service center. If you need assistance in locating any accessory, please contact DEWALT Industrial Tool Co., 701 East Joppa Road, Towson, MD 21286, call 1-800-4-DEWALT (1-800-433-9258) or visit our website: www.dewalt.com.

Register Online

Thank you for your purchase. Register your product now for:

- **WARRANTY SERVICE:** Registering your product will help you obtain more efficient warranty service in case there is a problem with your product.
- **CONFIRMATION OF OWNERSHIP:** In case of an insurance loss, such as fire, flood or theft, your registration of ownership will serve as your proof of purchase.
- **FOR YOUR SAFETY:** Registering your product will allow us to contact you in the unlikely event a safety notification is required under the Federal Consumer Safety Act.

Register online at www.dewalt.com/register.

Three Year Limited Warranty

DEWALT will repair, without charge, any defects due to faulty materials or workmanship for three years from the date of purchase. This warranty does not cover part failure due to normal wear or tool abuse. For further detail of warranty coverage and warranty repair information, visit www.dewalt.com or call 1-800-4-DEWALT (1-800-433-9258). This warranty does not apply to accessories or damage caused where repairs have been made or attempted by others. This warranty gives you specific legal rights and you may have other rights which vary in certain states or provinces.

In addition to the warranty, DEWALT tools are covered by our:

1 YEAR FREE SERVICE

DEWALT will maintain the tool and replace worn parts caused by normal use, for free, any time during the first year after purchase.

2 YEARS FREE SERVICE ON DEWALT BATTERY PACKS

DC9071, DC9091, DC9096, DC9280, DC9360, DC9180, DCB120, DCB127, DCB201, DCB203 and DCB207.

3 YEARS FREE SERVICE ON DEWALT BATTERY PACKS

DCB200, DCB204, DCB205

DEWALT BATTERY PACKS

Product warranty voided if the battery pack is tampered with in any way. DEWALT is not responsible for any injury caused by tampering and may prosecute warranty fraud to the fullest extent permitted by law.

90 DAY MONEY BACK GUARANTEE

If you are not completely satisfied with the performance of your DEWALT Power Tool, Laser, or Nailer for any reason, you can return it within 90 days from the date of purchase with a receipt for a full refund – no questions asked.

LATIN AMERICA: This warranty does not apply to products sold in Latin America. For products sold in Latin America, see country specific warranty information contained in the packaging, call the local company or see website for warranty information.

FREE WARNING LABEL REPLACEMENT: If your warning labels become illegible or are missing, call 1-800-4-DEWALT (1-800-433-9258) for a free replacement.

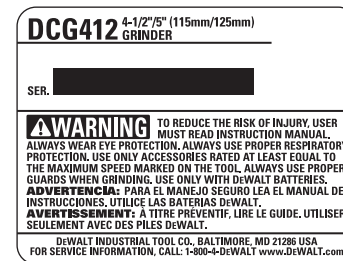

ADVERTENCIA: SOLAMENTE SIEMPRE SE DEBERA LLEVAR LA PROTECCION APROPIADA PARA LA VISTA Y PARA LAS VIAS RESPIRATORIAS. UTILICE UNICAMENTE ACCESORIOS CON UNA CAPACIDAD NOMINAL AL MENOS IGUAL A LA VELOCIDAD MAXIMA INDICADA EN LA HERRAMIENTA. SIEMPRE UTILICE PROTECTORES AL ESMERILAR.

AVERTISSEMENT: IL FAUT TOUJOURS PORTER DE L'EQUIPEMENT DE PROTECTION OCULAIRE ET RESPIRATOIRE APPROPRIE. UTILISER UNIQUEMENT DES ACCESSOIRES CONCUS POUR UN REGIME AU MOINS EGAL AU REGIME MAXIMUM INSCRIT SUR L'OUTIL ELECTRIQUE. TOUJOURS UTILISER LES PROTECTIONS APPROPRIEES PENDANT LE MEULAGE.

English

DeWALT Battery and Charger Systems																											
		Chargers/Charge Time (Minutes) - Chargeurs/Durée de charge (Minutes) - Cargadores de baterías/Tiempo de carga (Minutos)																									
Battery Cat #	Output Voltage	120 Volts																			12 Volts						
		DC011	DC022	DC9000	DC9310	DC9320	DCB085	DCB100	DCB101	DCB102	DCB103	DCB106	DCB107	DCB112	DW911	DW9106	DW9107	DW9108	DW9116	DW9117	DW9118	DW9216	DW9226	DW0246	DCB119	DW0249	DW9109
DC9360	36	X	X	45	X	X	X	X	X	X	X	X	X	X	X	X	X	X	X	X	X	X	X	X	X	X	X
DCB361	36	X	X	45	X	X	X	X	X	X	X	X	X	X	X	X	X	X	X	X	X	X	X	X	X	X	X
DC9280	28	X	X	60	X	X	X	X	X	X	X	X	X	X	X	X	X	X	X	X	X	X	X	X	X	X	X
DW9242	24	X	X	X	X	X	X	X	X	X	X	X	X	X	X	X	X	X	X	X	X	X	X	60	X	60	X
DCB200	20	X	X	X	X	X	X	X	X	60	60	140	90	X	X	X	X	X	X	X	X	X	X	X	90	X	X
DCB201	20	X	X	X	X	X	X	X	30	30	30	70	70	45	X	X	X	X	X	X	X	X	X	X	45	X	X
DCB203	20	X	X	X	X	X	X	X	35	35	35	90	90	60	X	X	X	X	X	X	X	X	X	60	X	X	
DCB204	20	X	X	X	X	X	X	X	70	70	70	185	185	120	X	X	X	X	X	X	X	X	X	120	X	X	
DCB205	20	X	X	X	X	X	X	X	90	90	90	240	240	150	X	X	X	X	X	X	X	X	X	150	X	X	
DCB207	20	X	X	X	X	X	X	X	30	30	30	60	60	40	X	X	X	X	X	X	X	X	X	X	X	X	
DC9096	18	60	60	X	60	60	X	X	X	60	X	X	X	60	X	X	60	60	20	X	60	130	X	X	X	60	
DC9099	18	45	45	X	45	45	X	X	X	45	X	X	X	45	X	X	45	15	X	45	95	X	X	X	45	45	
DC9180	18	X	X	X	60	60	X	X	X	60	X	X	X	X	X	X	X	X	X	X	X	X	X	X	X	60	
DC9181	18	X	X	X	30	30	X	X	X	30	X	X	X	X	X	X	X	X	X	X	X	X	X	X	X	30	
DW9096	18	60	60	X	60	60	X	X	X	60	X	X	X	60	X	X	60	60	20	X	60	130	X	X	X	60	
DW9098	18	30	30	X	30	30	X	X	X	30	X	X	X	30	X	X	30	30	12	X	30	60	X	X	X	30	
DW9099	18	45	45	X	45	45	X	X	X	45	X	X	X	45	X	X	45	15	X	45	95	X	X	X	45	45	
DC9091	14.4	60	60	X	60	60	X	X	X	60	X	X	X	60	60	60	60	20	115	60	115	X	X	X	60	60	
DC9094	14.4	45	45	X	45	45	X	X	X	45	X	X	X	45	60	45	45	45	15	90	45	90	X	X	X	45	
DW9091	14.4	45	45	X	45	45	X	X	X	45	X	X	X	45	60	45	45	45	15	90	45	90	X	X	X	45	
DW9094	14.4	30	30	X	30	30	X	X	X	30	X	X	X	30	45	30	30	30	12	60	30	60	X	X	X	30	
DCB120	12	X	X	X	X	X	X	40	30	30	30	X	60	45	X	X	X	X	X	X	X	X	X	45	X	X	
DCB127	12	X	X	X	X	X	X	35	35	35	X	90	60	X	X	X	X	X	X	X	X	X	X	60	X	X	
DC9071	12	60	60	X	60	60	X	X	X	60	X	X	X	60	90	60	60	60	20	115	60	115	X	X	X	60	
DW9050	12	X	X	X	X	X	X	X	X	X	X	X	X	40	X	X	X	X	X	X	X	X	X	X	X	X	
DW9071	12	45	45	X	45	45	X	X	X	45	X	X	X	45	60	45	45	45	15	90	45	90	X	X	X	45	
DW9072	12	30	30	X	30	30	X	X	X	30	X	X	X	30	45	30	30	30	12	60	30	60	X	X	X	30	
DW9048	9.6	X	X	X	X	X	X	X	X	X	X	X	X	40	X	X	X	X	X	X	X	X	X	X	X	X	
DW9061	9.6	45	45	X	45	45	X	X	X	45	X	X	X	45	60	45	45	45	15	90	45	90	X	X	X	45	
DW9062	9.6	30	30	X	30	30	X	X	X	30	X	X	X	30	45	30	30	30	12	60	30	60	X	X	X	30	
DCB080	8	X	X	X	X	X	60	X	X	X	X	X	X	X	X	X	X	X	X	X	X	X	X	X	X	X	
DW9057	7.2	30	30	X	30	30	X	X	X	30	X	X	X	30	45	30	30	30	12	60	30	60	X	X	X	30	

X Indicates that the battery pack is not compatible with that specific charger.
 X indique que le bloc-piles n'est pas compatible avec ce chargeur.
 Una *X* indica que el paquete de baterías no es compatible con ese determinado cargador.
All charge times are approximate. Actual charge time may vary. Read the instruction manual for more specific information.
 Les durées de charge sont approximatives; la durée de charge réelle peut varier. Lire le manuel d'utilisation pour obtenir des renseignements plus précis.
 El tiempo de duración de carga es aproximado; la duración de carga real puede variar. Lea el manual de instrucciones para obtener información más precisa.

- * Maximum initial battery voltage (measured without a workload) is 20 volts. Nominal voltage is 18.
- * La tension initiale maximum du bloc-piles (mesurée à vide) est de 20 volts. La tension nominale est de 18.
- * El máximo voltaje inicial de la batería (medido sin carga de trabajo) es 20 voltios. El voltaje nominal es de 18.

DeWALT Industrial Tool Co., 701 East Joppa Road, Towson, MD 21286
 (MAR14) Part No. N382880 DCG412 Copyright © 2012, 2014 DeWALT

The following are trademarks for one or more DeWALT power tools: the yellow and black color scheme, the "D" shaped air intake grill, the array of pyramids on the handgrip, the kit box configuration, and the array of lozenge-shaped humps on the surface of the tool.